



BuzziFold

Product Specification Sheet

This document contains technical information about the BuzziFold







www.buzzi.space

A sustainable solution for your ceilings

BuzziFold, made from sustainable BuzziFelt, can be ceiling-suspended horizontally or vertically. The former permits BuzziFold to act as a classic baffle, while the latter can also help create visual privacy between workstations or various zones. BuzziFold arrives fully assembled, making it an easy-to-install acoustic solution.

Design by BuzziSpace Studio

General

-  BuzziFold
Fixing: Wall | Suspended
-  BuzziFelt
Black Distance holders in recycled PP
Black metal wall support
-  Fixation: Wall mounted | Ceiling suspended horizontal and vertical
Black or Alu cables 2 or 5 m | 78.74" or 196.85"
Optional extra layer on one side in CAT A BuzziFabric. Only in combination with OffWhite or Anthracite felt.
-  **A** If installing on suspended ceiling, verify load capacity prior to installation.

Acoustics

-  Attenuation
-  Diffusion
-  Mid tone
-  High tone

Content

| | |
|----------------|---|
| Configurations | 3 |
| Fabrics | 4 |
| Components | 5 |
| Dimensions | 7 |

Configurations

BuzziFold Suspended

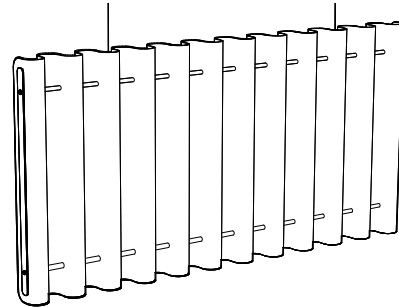
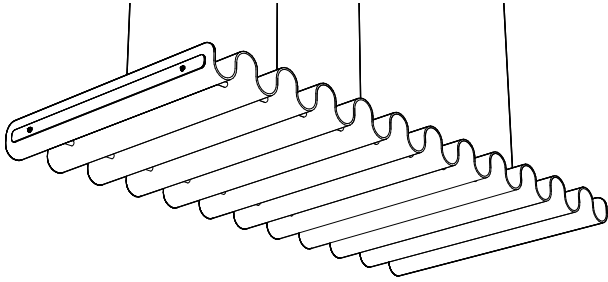

- 🌲 BuzziFelt
Black Distance holders in recycled PP

- ✂ Length: 193 cm | 75.98"
✂ Width: 95 cm | 37.40"
✂ Depth: 12 cm | 4.72"

- ⚖ Felt: 4,4 kg | 9.70 lbs
Fabric Covered: 6,4 kg | 14.11 lbs

Black or Alu cables 2 – 5m | 78.74" – 196.85"

- ⋮ Optional extra layer on one side in CAT A BuzziFabric. Only in combination with OffWhite or Anthracite felt.
- ⚠ If installing on suspended ceiling, verify load capacity prior to installation.

BuzziFold Wall Mounted

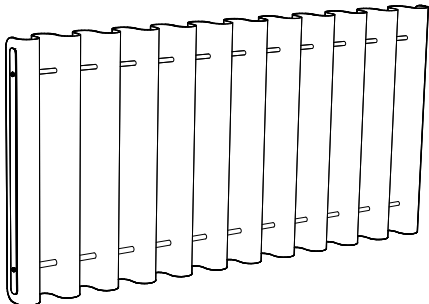

- 🌲 BuzziFelt
Black Distance holders in recycled PP
Black metal wall support

- ✂ Length: 193 cm | 75.98"
✂ Width: 95 cm | 37.40"
✂ Depth: 12 cm | 4.72"

- ⚖ Felt: 4,4 kg | 9.70 lbs
Fabric Covered: 6,4 kg | 14.11 lbs

- ⋮ Optional extra layer on one side in CAT A BuzziFabric. Only in combination with OffWhite or Anthracite felt.

Fabrics

Felt

Composition 100% Recycled P.E.T. Felt, latex backing

Weight 1.000 g/m² | 29.49 oz/yd²

Abrasion resistance >7.000 Martindale

Flammability EU: EN 13501.1 + A1/2009 Class B-s1,d0
USA: ASTM E84 Class A certified

Fastness to light USA 5

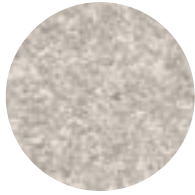

FE-OffWhite 63*

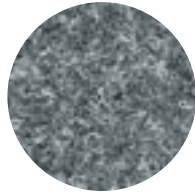

FE-StoneGrey 67



FE-Antracite 68*

*Extra layer BuzziFabric Possible

Fabric

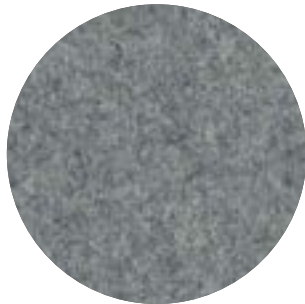

Category A

Composition 70% Recycled Wool, 25% Recycled Polyacryl,
5% Recycled Other Fabrics

Weight 405 g/m² | 11.94 oz/yd²

Abrasion resistance 40.000 Martindale, 50.000 Wyzenbeek

Flammability EU: EN 1021.1/2006 | BS EN 1021.1/2006 (cigarette).
EN 1021.2/2006 | BS EN 1021.2/2006 (match)

USA: CAL TB 117 | ASTM E84 CLASS A

Fastness to light EU: 4 | USA 4

Fastness to rubbing EU: Wet 3-4 | Dry 4-5

Fastness to crocking USA: Wet 5 | Dry 5



Components

Distance holder

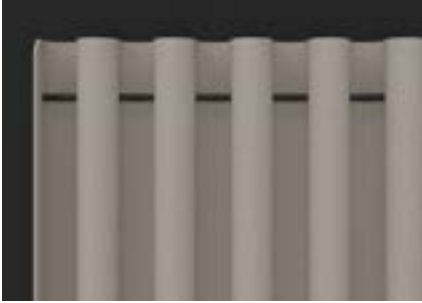

Black 100% Polypropylene distance holders to ensure an even distribution of the Felt waves.

Fixing System

Fixing system ceiling suspended horizontal

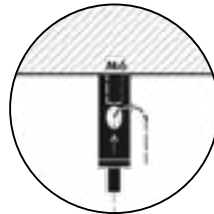
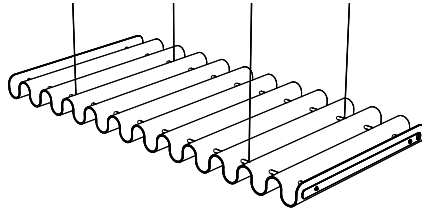

4 cables of 2 or 5 m
Black or aluminium colored cables

By adjusting the length of the cables the Fold Horizontal can be twisted.

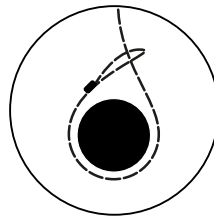
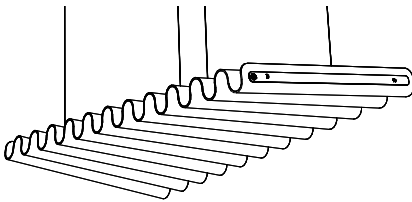

Formations, as with other architectural features located in the ceiling plane, may obstruct or skew the existing or planned fire sprinkler water distribution pattern, or possibly delay the activation of the fire sprinkler or fire detection system.

Designers and installers are advised to consult a protection engineer, NFPA 13 and their local codes for guidance on the proper installation techniques where detection or suppression systems are present.

Fixing system ceiling suspended vertical

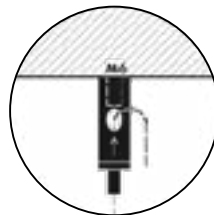
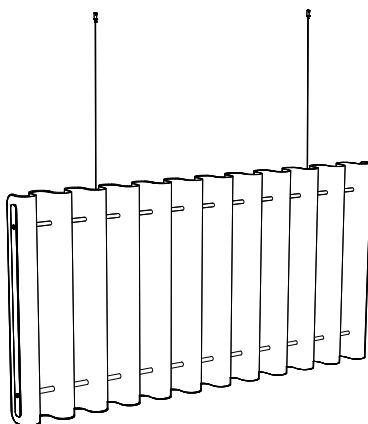

2 cables of 2 or 5 m
Black or aluminium colored cables

Formations, as with other architectural features located in the ceiling plane, may obstruct or skew the existing or planned fire sprinkler water distribution pattern, or possibly delay the activation of the fire sprinkler or fire detection system.

Designers and installers are advised to consult a protection engineer, NFPA 13 and their local codes for guidance on the proper installation techniques where detection or suppression systems are present.

Fixing system wall

2 pieces of black metal wall mount

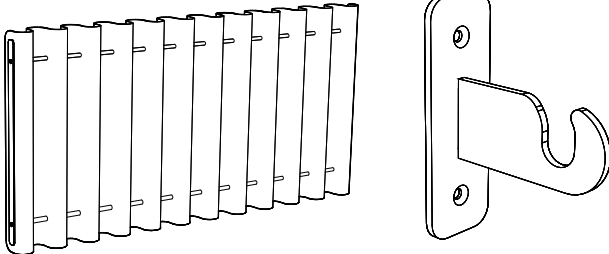

Dimensions

Fold

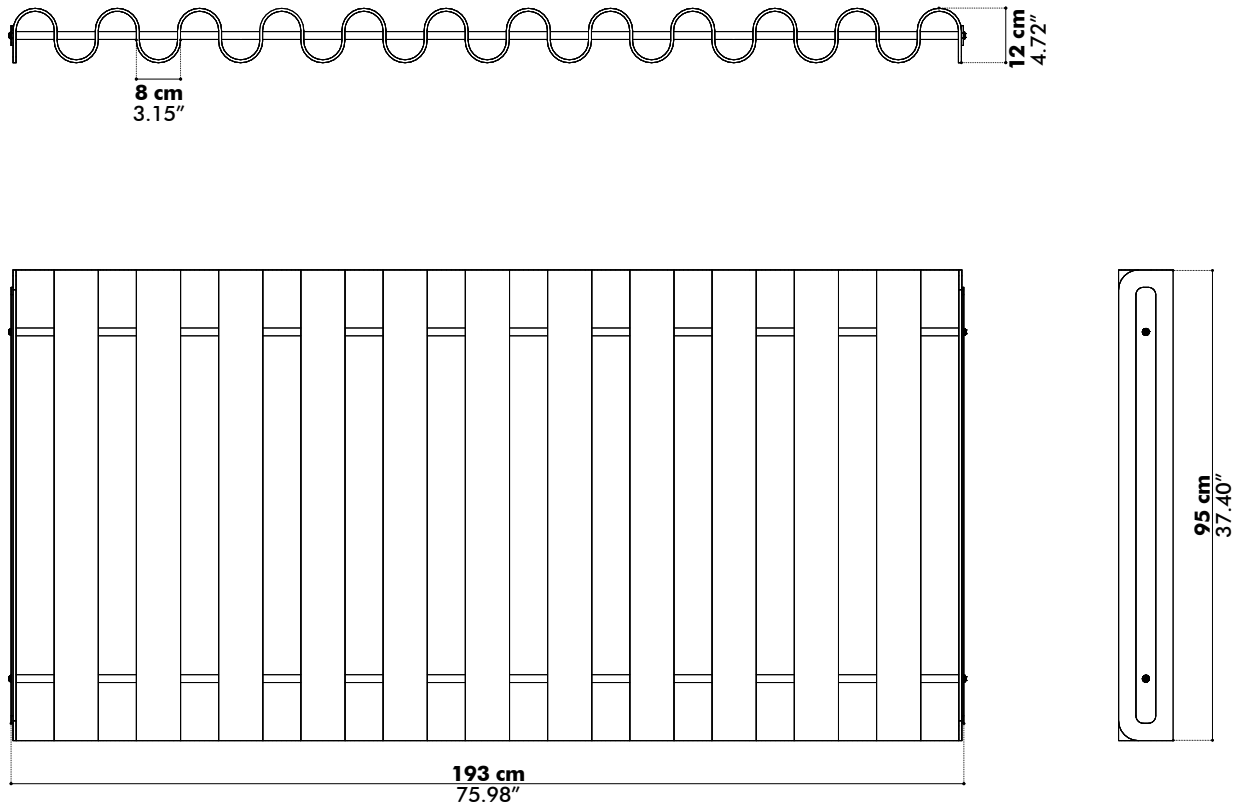

Wall mount

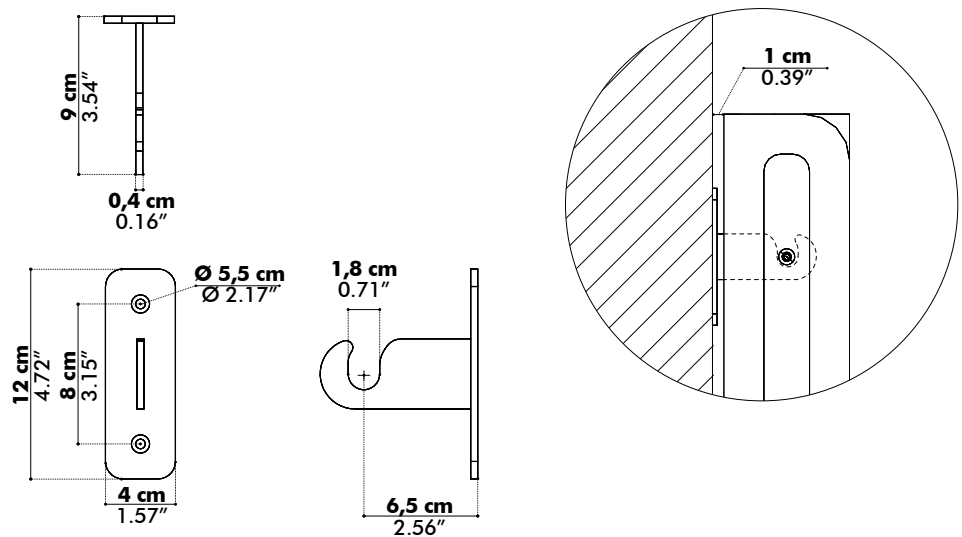

Acoustics

BuzziFold

Equivalent sound absorption area in m² per object

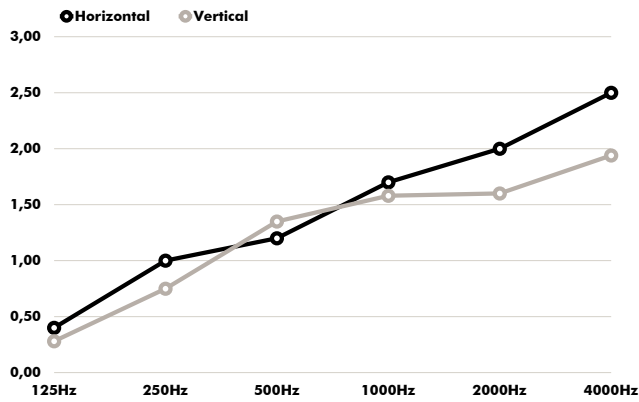

| Hz | Horizontal Aeq/m ² | Vertical Aeq/m ² |
|------|-------------------------------|-----------------------------|
| 125 | 0.4 | 0.28 |
| 250 | 1.0 | 0.75 |
| 500 | 1.2 | 1.35 |
| 1000 | 1.7 | 1.58 |
| 2000 | 2.0 | 1.60 |
| 4000 | 2.5 | 1.94 |